

## Data Sheet - Revolving Sign Mechanisms

### Revolving Sign Mechanisms

A revolving sign mechanism from Movetech UK can give you the competitive edge. Ideal for a wide variety of locations, both indoor and out, a revolving sign will attract attention, whether inside a shopping mall, an exhibition or on top of a multi-storey building. Versatile and cost-effective, Movetech UK's revolving mechanisms are precision engineered to ensure optimum performance. They are reliable and durable, giving many years of trouble-free operation.



### The Great Outdoors

Many great companies, both large and small, have recognised the value of movement by revolving their logo or customer message outside, earmarking their location and adding value to the brand. To meet their requirements we have a wide range of models available, suitably weatherproofed to cope with all but the severest of climate conditions, and capable of carrying large signs. A call to our technical sales team will confirm which is the best mechanism for your project and conditions.



The speed of movement may vary depending on the velocity of the wind.

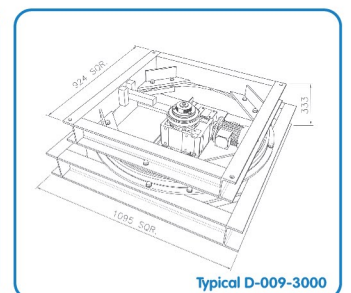
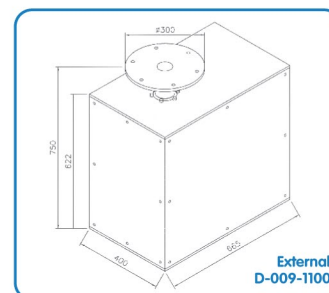

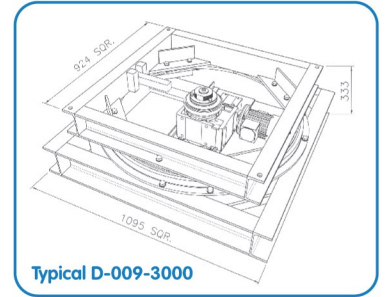

## A Selling Force

Advertising your product or service with a moving message sells. It's a fact – research by POPAI (Point Of Purchase Advertising International) has shown that movement in the retail environment can increase sales by more than 30%. Spreading the word to a wide range of public areas such as shopping malls, hotel lobbies and airport waiting areas will reinforce the brand, imprinting the name on the reader's mind, creating an impulse to buy.

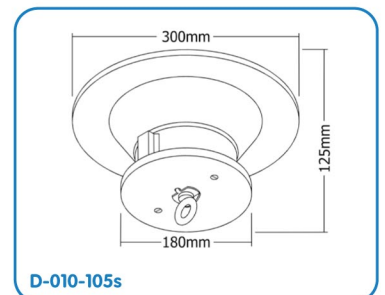
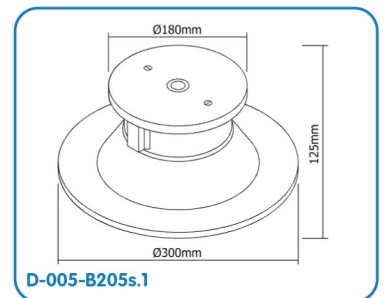
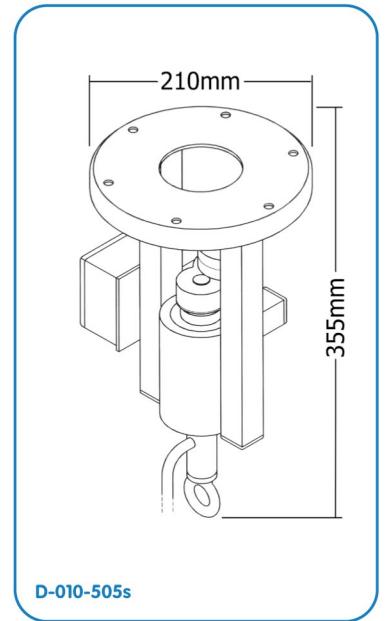

## On Show

Where better to use a revolving sign than at a major show? Use the venue's height to lift your brand above the competition and make an exhibition of yourself! Or use one at eye-level to attract the visitor to your stand. Countless Movetech UK customers find attention-grabbing movement a stylish and cost-effective way to ensure they are seen.

## Benefits of a Revolving Sign

- > Movement attracts - increases exposure/prominence of sales or advertising message.
- > Using movement can extend the brand or advertising message over a static sign.
- > Multi-use of a message, multi-creation of separate fascias.
- > Creates a visual draw to the eyes where a normal prominent position is not available.
- > Attracts visitors.
- > Allows brands exposure and recognition at long distance.
- > Enhances and creates a brand image.
- > Movement can signify when an outlet/establishment is open or closed.



Product Code	Product Description	Slip Rings	Speed (RPM)	Unit Dimensions			Max Display Properties		
				Diameter (mm)	Height (mm)	Weight (kg)	Diameter (mm)	Height (mm)	Capacity (kg)
D-005-B205s.1	B200 Display turntable with slip rings Internal - Clockwise & Anti-clockwise	Yes	2	300	125	3.500	760	910	90
D-005-Mini.STD	Mini Carousel 450mm Display turntable Internal - Clockwise & Anti-clockwise	Yes	1	450	170	15.000	1500	1500	227
D-010-105s	Ceiling mounted turntable - 105 with slip rings Internal - Clockwise & Anti-clockwise	Yes	2	300	125	3.600	1200	1000	45
D-010-505s	Ceiling mounted turntable - 505 with slip rings Internal - Clockwise & Anti-clockwise	Yes	2	210	355	7.500	1500	1200	227
D-009-0080	Sign turntable - 080	Yes	4	300	546	25.00	TBA	TBA	TBA
D-009-0700	Sign turntable - 0700	Yes	3	400x300	635	35.000	TBA	TBA	TBA
D-009-1100	Sign turntable - 1100	Yes	4	665x400	750	50.000	TBA	TBA	TBA
D-009-3000	Sign turntable - 3000	Yes	0.75	1090x965	340	250.000	TBA	TBA	TBA

## Can't find what you are looking for?

Movetech UK's range extends to smaller battery and solar powered movement as well as much larger units. The product portfolio includes off-the-shelf revolving stages up to 33m in diameter, and Movetech UK also offers a bespoke design and build service to cater for all customers needs.

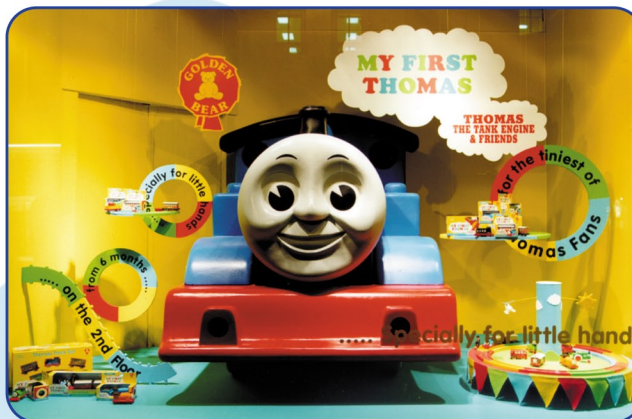

In addition, an economical rental service is available. To discuss your requirements or for further information please contact Movetech UK - 01204 525626 - info@movetechuk.com - www.movetechuk.com